 Printed on recycled paper.

  
Science & Technology Review  
Lawrence Livermore National Laboratory  
P.O. Box 808, L-664  
Livermore, California 94551

# Science & Technology

REVIEW

September 1996

Lawrence  
Livermore  
National  
Laboratory



Beyond Fusion Ignition  
to Inexhaustible Power  
Using Lasers

*Also in this issue:*

- Metallized Hydrogen
- Computer Modeling of Human Joints

Nonprofit Org.  
U.S. Postage  
**PAID**  
Livermore, CA  
Permit No. 154



## About the Cover

This month's feature article on lasers beyond the National Ignition Facility concentrates on the diode-pumped solid-state laser. Surrounding it on the cover are some of the primary technological developments that make it a candidate for the means by which inertial confinement fusion will create inertial fusion energy as an inexhaustible source of electric power. Clockwise from the upper left are: a ytterbium-doped strontium-fluorapatite (Yb:S-FAP) crystal from which the laser's gain element is made; a diode array, the source of laser's pump light; a single laser diode package; a Yb:S-FAP crystal; and a lens duct. For our report on how these components work together to take lasers beyond NIF, turn to p. 4.



Cover photo: James E. Stoots

## What Do You Think?

We want to know what you think of our publication. Please use the enclosed survey form to give us your feedback.

## Electronic Access

S&TR is available on the Internet at <http://www.llnl.gov/str>. As references become available on the Internet, they will be interactively linked to the footnote references at the end of each article. If you desire more detailed information about an article, click on any reference that is in color at the end of the article, and you will connect automatically with the reference.

## About the Review



Lawrence Livermore National Laboratory is operated by the University of California for the Department of Energy. At Livermore, we focus science and technology on assuring our nation's security. We also apply that expertise to solve other important national problems in energy, bioscience, and the environment. *Science & Technology Review* is published ten times a year to communicate, to a broad audience, the Laboratory's scientific and technological accomplishments in fulfilling its primary missions. The publication's goal is to help readers understand these accomplishments and appreciate their value to the individual citizen, the nation, and the world.

Please address any correspondence (including name and address changes) to S&TR, Mail Stop L-664, Lawrence Livermore National Laboratory, P.O. Box 808, Livermore, California 94551, or telephone (510) 422-8961. Our electronic mail address is [hunter6@llnl.gov](mailto:hunter6@llnl.gov).

## S&TR Staff

**SCIENTIFIC EDITORS**  
Becky Faylor and Ravi Upadhye

**PUBLICATION EDITOR**  
Dean Wheatcraft

**WRITERS**  
Sam Hunter, Robert D. Kirvel, and Dale Sprouse

**ART DIRECTOR**  
George Kitrinov

**DESIGNER**  
George Kitrinov

**GRAPHIC ARTIST**  
Treva Carey

**COMPOSITOR**  
Louisa Cardoza

**PROOFREADERS**  
Ellen Shorr and Jill Sprinkle

S&TR is a Director's Office publication, produced by the Technical Information Department, under the direction of the Office of Policy, Planning, and Special Studies.

Printed in the United States of America

Available from  
National Technical Information Service  
U.S. Department of Commerce  
5285 Port Royal Road  
Springfield, Virginia 22161

UCRL-52000-96-9  
Distribution Category UC-700  
September 1996

# Science & Technology REVIEW

September 1996

Lawrence  
Livermore  
National  
Laboratory

## 2 The Laboratory in the News

## 3 Commentary by E. Michael Campbell The Next Frontiers of Advanced Lasers Research

## Features

## 4 Taking Lasers beyond the National Ignition Facility

One ultimate goal of laser fusion research is to produce electricity by inertial confinement fusion. Advances in our diode-pumped laser technology promise to take us another step closer to that goal.

## 12 Jumpin' Jupiter! Metallic Hydrogen

Capitalizing on its expertise in shock compression, a Laboratory team was the first to provide evidence for the metallization of hydrogen since the theory was advanced in the 1930s.

## Research Highlight

## 19 Modeling Human Joints and Prosthetic Implants

## 24 Patents and Awards

## Abstracts



Page 4



Page 12

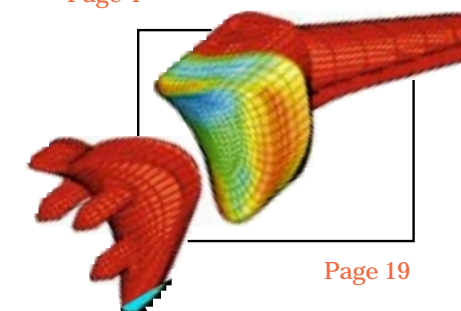

Page 19



Prepared by LLNL under contract  
No. W-7405-Eng-48

**Livermore, IBM to build world's fastest supercomputer**

Lawrence Livermore has awarded IBM a \$93-million contract to build the world's fastest supercomputer—a machine designed to deliver 3 trillion calculations per second (3 teraflops). The 3-teraflop IBM RS/6000 SP production model is scheduled for demonstration in December 1998.

Most of today's supercomputers are capable of performance in the gigaflop or billion-calculations-per-second range, notes Dave Cooper, Associate Director for Computations at Livermore, who suggests that "If computing at gigaflops were represented by a one-way trip between San Francisco and Los Angeles, then computing at teraflops represents a round trip between San Francisco and the moon in the same amount of time."

The Livermore-IBM collaboration is the latest project in the Department of Energy's 10-year, \$1-billion Accelerated Strategic Computing Initiative program. The program, which involves three major DOE facilities (Livermore, Los Alamos, and Sandia national laboratories), calls for five generations of high-performance computers. Development of the first generation ASCI machine—a 1.8-teraflop computer—is under way, teaming Sandia with Intel Corporation. The three other supercomputers that ASCI wants developed will deliver calculation capability in the 10-, 30-, and 100-teraflop range.

In discussing the IBM contract in late July, Lawrence Livermore Director Bruce Tarter said that he expects this project to provide Livermore and the other national laboratories involved in ASCI "with an opportunity to lead the next revolution in high-performance computing in support of important national security objectives."

ASCI supercomputers will be used to construct three-dimensional simulations of stockpiled nuclear warheads, allowing DOE scientists to analyze effects of weapons aging and the implications of potential problems. According to David Nowak, head of the ASCI program at Livermore and a former weapon designer, "Numerical simulation is the glue that holds stockpile stewardship together."

Advanced computations, specifically three-dimensional modeling and simulation capability, are central components of "stockpile stewardship"—the safe and reliable maintenance of the nation's nuclear arsenal in the absence of nuclear testing. Tera-scale computing also will provide a commercial platform for medical simulations, global climate modeling, aerospace and automotive design, and other applications.

The system will be based on a building block approach to high-performance computing in which the system consists of clusters of shared-memory processors. The new supercomputer will be designed to accommodate as many as 512 nodes with

eight processors per node to perform numeric- and data-intensive tasks. It will be delivered with 2.5 trillion bytes of memory, as compared with existing high-end systems in which the memory is measured in billions of bytes or with personal computers where the memory is measured in tens of millions of bytes. It can be easily switched between a secure environment for national security applications and an open environment for university collaboration.

According to Nowak, the system naturally scales to the 10-teraflop range by increasing both the processor speed and the number of processors per node.

Contact: Dave Nowak (510) 423-6706 (nowak1@llnl.gov).

**Lab receives six awards for R&D innovation**

*R&D Magazine* will honor Laboratory researchers in Philadelphia next month at its annual R&D 100 Awards dinner. Each year, the magazine selects the top 100 commercially viable research and development advances to receive its coveted award, considered by many the R&D community's "Oscar."

This year, the magazine cited six technologies developed at Lawrence Livermore for R&D 100 honors. That brought to 61 the number of awards the magazine has bestowed on Laboratory R&D teams since 1978, when Livermore began participating in the competition.

Two of our award-winning developments this year involve industrial partnering agreements. Five stem from research pursuits in our Laser Programs.

Alan Bennett, director of our office of Industrial Partnerships and Commercialization, described this year's R&D 100 honors to the Laboratory as "a tribute to the ongoing excellent scientific and technical work that routinely takes place here." Said Bennett: "Once again, Laboratory scientists have shown that ideas developed in the course of our mission activities may have tremendous benefits for the U.S. economy."

Here is a brief look at the Laboratory's 1996 R&D 100 Award winners. Each will be reported on in detail in the October issue of *S&TR*.

**Latest MIR use: the electronic dipstick**

The Lab's Micropower Impulse Radar (MIR) technology has once again been honored by *R&D Magazine*, this time for MIR's latest application: an "electronic dipstick" to sense the level of fluid or other material stored in tanks, vats, and silos. The dipstick also can be used in automobiles to read levels of a variety of fluids: gasoline, oil, transmission fluid, coolant, and windshield cleaner.

(continued on page 22)

**The Next Frontiers of Advanced Lasers Research**

**W**HEN the National Ignition Facility comes on-line in 2003, it will represent the conclusion of one process and the beginning of others. It will be the culmination of more than a decade of research and development to achieve laser ignition—the implosion in a laboratory environment of a small, hydrogen-isotope-filled target by laser beams of sufficient energy and quality to create, for a micro-instant, inertially confined fusion—a process comparable to that at the center of the sun. Simultaneously, it will represent the beginning of other quests, among them to fulfill the ultimate civilian goal of NIF—taking lasers beyond NIF to enable them to create inertial fusion energy, a low-cost, inexhaustible supply of electric power through repeated, sustained laser ignition and fusion energy gain.

Lawrence Livermore National Laboratory recognized and embraced the challenge of taking lasers beyond NIF more than a decade ago, even before NIF was specifically defined. The Laboratory made the early commitment to identify and develop the concepts and technologies that would propel laser applications beyond NIF because we know that the design, development, and construction of each major new experimental program facility take at least 10 years or more. Therefore, positioning large-scale programs to be able to explore the frontiers of new knowledge calls for the earliest possible anticipation of program facility needs and the timely development of the necessary enabling technologies.

In the case of NIF, these research management principles have meant that as the Laboratory solved the scientific problems and developed the technology to make NIF a reality, we almost concurrently had to do the science and provide the technology to take lasers beyond NIF.

Two articles in this issue of *Science & Technology Review* report on developments that not only will help inertial fusion achieve its immediate goal—ignition—but may provide the enabling technology to make lasers the means of providing inertial fusion energy.

The feature article, "Taking Lasers beyond the National Ignition Facility," beginning on p. 4, makes the compelling point that the flashlamp-pumped neodymium-doped glass (Nd:glass) lasers that NIF will use to create fusion ignition

represent several decades of development and scaling. Flashlamp-pumped solid-state lasers have been developed worldwide as the workhorse laser driver of choice for single-shot inertial confinement fusion and high-energy-density research facilities at Livermore and elsewhere. Yet, it was generally believed that solid-state lasers as a class lacked other qualities necessary to effectively drive an inertial fusion energy reactor—namely, the capability to generate fusion-like, megajoule pulse energies simultaneously with output beams characterized by high quality, high pulse-repetition rate (about 10 hertz), and high efficiency (greater than 10%). The article goes on to discuss the conceptual and technological innovations that overcame this long-held perception. It focuses on the part the Laboratory played in developing (concurrently with NIF) the enabling laser technology advances that make diode-pumped, gas-cooled solid-state lasers a candidate for taking lasers beyond NIF to the production of unlimited electrical power based on inertial fusion energy.

In a similar vein, the article on metallic hydrogen (p. 12) reports on a recent Laboratory achievement with promising, significant implications for improving the laser targets that will be used in NIF, broadening their performance range and making them capable of higher performance. The revised information about the equation of state of hydrogen revealed by the Laboratory's hydrogen metallization studies will contribute to the refinement of the hydrogen-isotope-filled targets to be used in the lasers that will make inertial fusion energy a reality.

Different as these two articles are, they have a similar subtext: The achievements they discuss illustrate the emphasis of Laboratory and the Laser Programs on forward-looking research management that plans well ahead for the future implications and applications of the scientific research and development done at Livermore. This research management philosophy is also what makes Lawrence Livermore a continuing key contributor to the global advancement of science and its most important applications.

■ E. Michael Campbell is the Associate Director, Laser Programs

# Taking Lasers beyond the National Ignition Facility

*By the year 2005, the National Ignition Facility is expected to achieve fusion ignition—a major step on the road to producing electricity by fusion. Now the Laboratory has developed and tested new diode-pumped laser technology that increases both the power of lasers and their ability to fire rapidly. These advanced capabilities promise to help us achieve the ultimate goal of producing electricity by inertial confinement fusion.*

**L**IKE computers and stereo equipment, state-of-the-art lasers continuously are improved by new developments. In fact, the laser's state of the art is being enhanced by a relative of one of the components used in CD players—the laser diode.

The laser diode, which produces purer monochromatic light than a flashlamp's full-spectrum of white light, is a candidate for taking the technology of Lawrence Livermore National Laboratory's planned National Ignition Facility (NIF) one step further. This technology, which can increase shot

rates by up to 100,000 times, may enable us eventually to produce electricity by inertial fusion energy (IFE).<sup>1</sup>

NIF is one of the key components of stockpile stewardship, our national strategy to maintain nuclear competence without underground testing.<sup>2</sup> It is based on a flashlamp-pumped laser capable of delivering 1.8 megajoules of energy directly or indirectly onto a target within a few billionths of a second.<sup>3</sup> This energy will induce plasma temperatures of millions of degrees and, in the case of indirect-

drive targets, create intense soft x-rays that can compress a deuterium-tritium pellet to high-density and high-temperature to realize ignition by inertial confinement fusion (ICF)—a feat we expect NIF to achieve in about the year 2005.

NIF will fire approximately once every 4 to 8 hours, which is appropriate for the needs of ICF in the research stage and of stockpile stewardship. However, future ICF needs could call for shot rates of once every few minutes, and the ultimate use of ICF—to produce electric power—will require 5 to 10 shots per second, an increase of over 100,000 times compared to the shot rate achievable with state-of-the-art fusion laser technology. Can a fusion laser driver operate at this much higher repetition rate? Lawrence Livermore's advanced laser design and small-scale experimental results indicate yes.

To date, all of the highest energy laser facilities have been based on flashlamp-pumped neodymium-doped glass (Nd:glass) lasers because they are most amenable to large-scale deployment and they provide the flexibility in output characteristics needed for ICF and weapons-related experiments. However, the completion of NIF, followed by the prospect of fusion ignition in the laboratory within the next decade, prompts the question of what technology will best meet our nation's future needs.

Figure 1, which illustrates how the output energy of solid-state lasers has progressed over the last two decades, shows that we are considering a shift

from flashlamp-pumped to diode-pumped solid-state lasers, with the objective of developing an advanced technology to provide "shots on demand" for ICF and stockpile stewardship. In fact, the diode-pump concept is ready to be developed for a broad array of near-term (kilojoule-level) Department of Energy and Department of Defense missions, as well as for longer-term megajoule applications.

## Advanced Laser Beamline

The next step in developing diode-pumped laser technology is to build a prototype beamline (i.e., a beamlet) of an advanced laser facility within the next five to ten years (Figure 2). The basic components of this laser are the diode-pump arrays, ytterbium-doped strontium-fluorapatite (Yb:S-FAP) crystals, and a gas-cooling system for these crystals to allow an increased

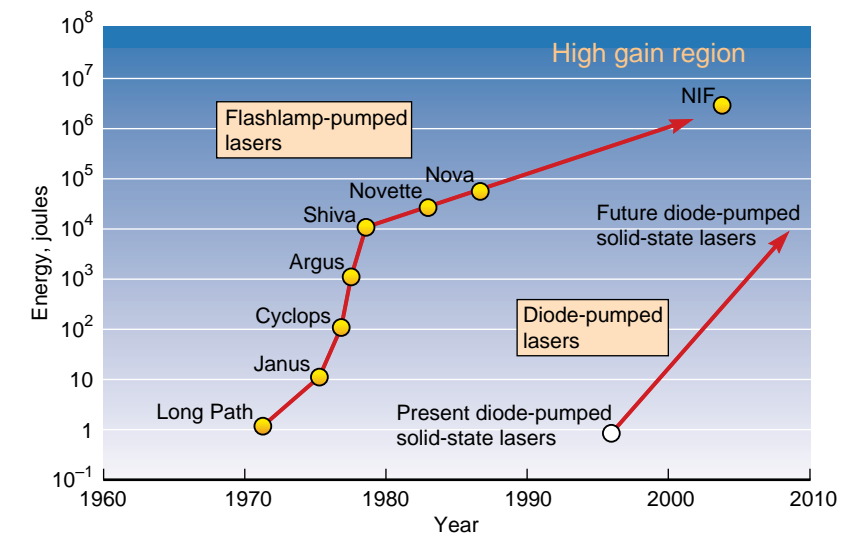

**Figure 1.** Maximum output energy of various LLNL laser fusion systems. Neodymium-doped glass laser technology will culminate with the construction of the National Ignition Facility, and next-generation diode-pumped laser technology will require development before it becomes relevant to high-energy/high-density physics experiments.

**Figure 2.** Model of a 1-kilojoule future "beamlet," based on diode-pumped solid-state laser technology, gas cooling of the laser slabs, and ytterbium-doped strontium-fluorapatite gain medium.



repetition rate. The facility would be capable of generating 1 kilojoule of energy on-target, at a repetition rate of up to 10 hertz, with a “wall-plug efficiency” of approximately 10%.

Figure 3 is a photograph of an LLNL-developed laser diode package containing a high-power laser diode array. This technology produces monochromatic light output (single wavelength) rather than the white light characteristic of flashlamps (where all colors are represented in the output), leading to higher efficiency operation and reduced heating of the laser crystals. Among the other crucial advantages that laser diodes offer over flashlamps is that they will be able to fire ten billion times without being replaced, while large flashlamps can offer only about 100,000 shots. We have already demonstrated one billion shots for diodes produced in our laboratories.

Laser diodes are revolutionizing telecommunications, where they are deployed in optical amplifiers for undersea applications (with anticipated 30-year operating lifetimes), CD players, and high-speed computer networks. Using diode-pump sources at the

megajoule-scale of fusion lasers, however, requires high peak power (large arrays of diodes rather than the single diodes commonly employed in industry today). The cost of the diodes must therefore be reduced to a “dime per watt,” compared to the “dollars per watt” presently available.

Our analysis of diode production costs suggests that this cost reduction is plausible but will require a large-scale application, such as laser fusion, to drive down the cost of diodes. Laser diodes also permit the long-term vision of electrical power production with fusion by virtue of their very high electrical-to-optical conversion efficiency (more than 50%). Thus, the overall efficiency of the diode-pumped solid-state laser can be more than 10 to 20%, because of the high efficiency of the diodes and the efficient manner in which their output can be delivered to the Yb:S-FAP crystals.<sup>4</sup>

The Yb:S-FAP crystals serve as the “gain medium,” which amplifies the light beam as it propagates through the laser chain. These novel crystals, invented at LLNL in 1991 and recognized with an R&D 100 Award, essentially will supplant the Nd:glass used in Nova and

NIF. The main advantage of Yb:S-FAP crystals is that they can store four times as much energy as Nd:glass for a given energy pumping rate.<sup>5</sup> They are also better able to conduct away excess heat than is laser glass.

Another crucial new technology that enables the high repetition rate needed for fusion is the gas-cooled slab,<sup>6</sup> as sketched in Figure 4. Cooling is needed because all lasers produce waste heat, which must be removed without disturbing the sensitive optics. Lawrence Livermore has developed the technique of flowing helium gas across the laser crystal surface in a turbulent manner at about one-tenth the speed of sound to conduct heat away from the crystals. Helium gas is employed because it has high thermal conductivity and causes only insignificant optical distortions. The heat and light pass through the same surface. Most importantly, the gas-cooled slab design has the added advantage of being readily scalable by increasing the area of the slab. This scalability is a critical issue because fusion lasers will operate in the megajoule range in an electrical power plant.

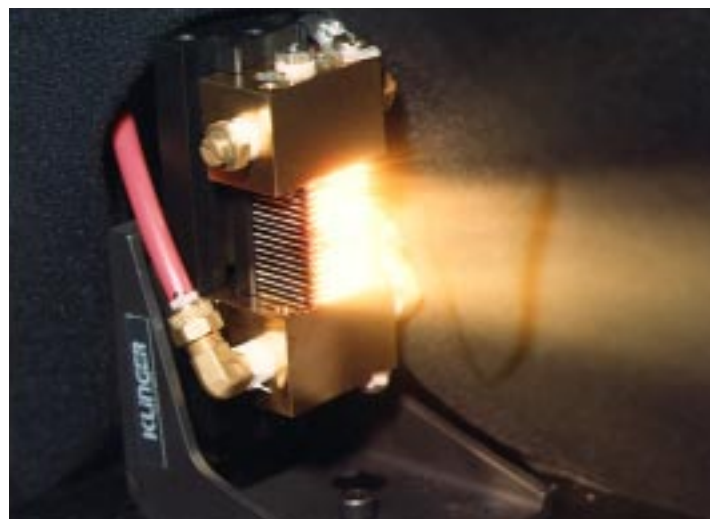
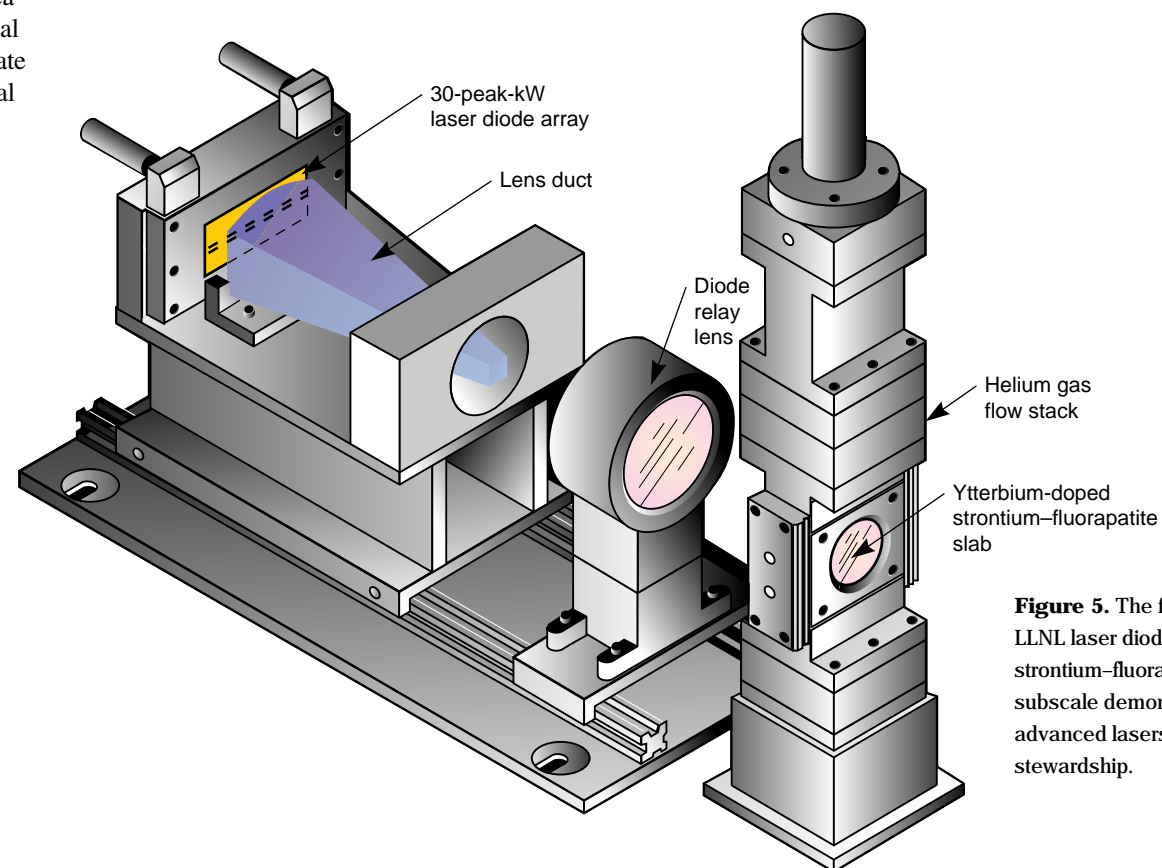

**Figure 3.** Laser diode array produced at LLNL, based on high-peak-power laser diode bars, efficient microchannel cooler packaging, and high-brightness microlens collimators.

## Prototype Applications

The most energetic diode-pumped solid-state lasers today generate about 1 joule of output energy in a pulse lasting a few nanoseconds. We believe a prototype beamline operating at about 1,000 joules (or even 100 joules) would have near-term utility for experiments and testing relevant to plasma physics and ICF. This facility could be run up to 10 hertz in repetition rate, although for most plasma physics and laser science experiments conducted today, it essentially will be capable of providing “shots on demand.” Examples of plasma physics experiments we would perform at the prototype beamline facility include:

- Average-power x-ray lasers.
- Average-power x-ray sources for imaging.
- Laser-induced shock physics and laser plasma interaction studies.

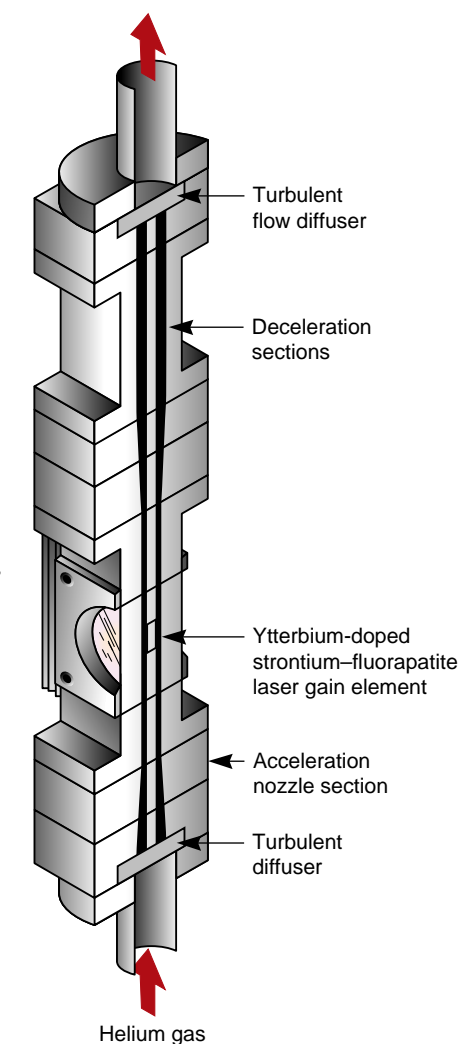

**Figure 5.** The first integrated laser module based on the use of LLNL laser diode arrays, gas cooling, and ytterbium-doped strontium-fluorapatite gain medium. This gas-cooled testbed is a subscale demonstration of the technology relevant to future advanced lasers for inertial confinement fusion and stockpile stewardship.

- X-ray diagnostics development. Optical experiments include:
  - Large-area multishot damage testing of NIF optics.
  - Debris shield survivability studies.
- Other important uses of a kilojoule facility are:
- Calibrating of x-ray cameras and other diagnostics.
  - Prototyping the design of a future megajoule facility.
  - Testing advanced laser concepts for inertial fusion energy.

## Small-Scale Demonstrations

One of the recent outcomes of the experimental program has been the gas-cooled slab testbed, shown in Figure 5.<sup>7</sup> This device integrates the accomplishments we have made over the last ten years: long-storage-time Yb:S-FAP gain medium, high-power laser diode



**Figure 4.** Schematic drawing of the gas-cooled slab concept illustrating the high-speed helium gas flow across the optical aperture that the laser light also traverses.

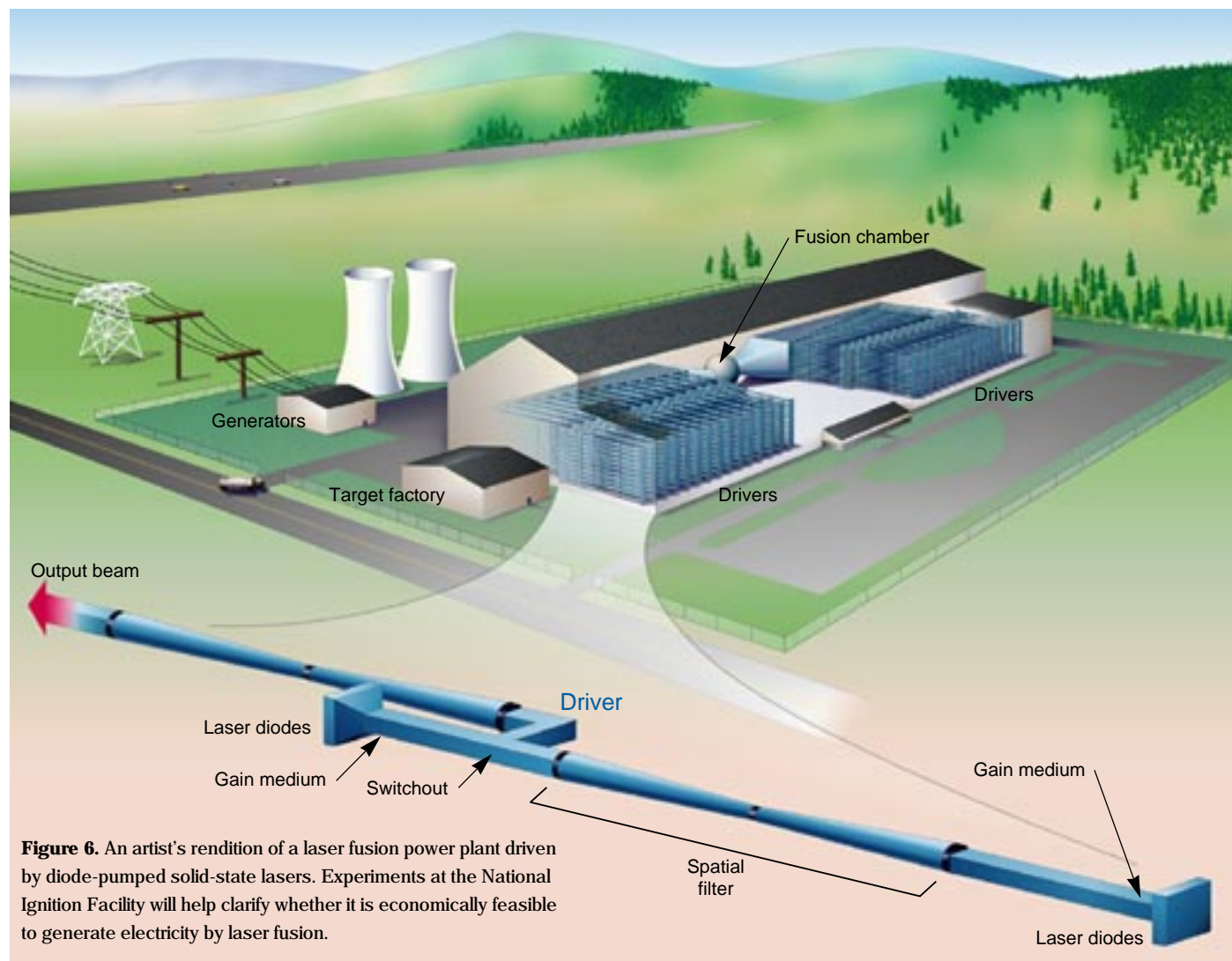

**Figure 6.** An artist's rendition of a laser fusion power plant driven by diode-pumped solid-state lasers. Experiments at the National Ignition Facility will help clarify whether it is economically feasible to generate electricity by laser fusion.

Illustration by Sandra K. Lynn

arrays, and turbulent gas cooling. The laser testbed demonstrates solutions to the technical hurdles that are unique to future high-repetition-rate fusion lasers. The laser has produced 50 watts of power output in a tabletop package, a power regime that is regarded as significant by the laser community. At 50 watts, the thermal load being transferred to the helium gas (flowing at about 0.1 Mach) is more than 3 watts per square centimeter. Our estimate of the requirement for a megajoule system running at 10 hertz is about 1 to 2 watts per square centimeter. The Yb:S-FAP laser slab

did not fracture until more than 50% of the theoretical stress limit of the material was reached, which is about two times higher than required for future megajoule ICF facilities.

Another crucial issue of diode-pumped technology involves the overall efficiency of the system. Our small Yb:S-FAP diode-pumped laser has yielded an overall electricity-to-light conversion efficiency of more than 10%.<sup>8</sup> We are working to correct some problems, such as impurity absorptions in the laser crystals and unoptimized optical coatings, and we believe that we can achieve an efficiency that exceeds

20% in long-pulse operations. To achieve this objective, the crystals and coatings need to have optical damage thresholds of greater than 10 joules per square centimeter for 10-nanosecond pulses. We have found that selected crystals that are completely free of defects meet this criterion, although increased quality control will be needed to attain this standard routinely.

### Energy Production Is Goal

An ultimate goal of all laser fusion efforts is to tap this inexhaustible source of producing electricity. Figure 6 is an

artist's rendition of a laser-driven ICF power plant, which consists of four parts: (1) drivers, which provide many intense laser beams focused onto targets, which are mass-produced in (2) the target factory and positioned in (3) the fusion chamber. When the beams hit the targets, bursts of fusion energy at 5 to 10 pulses per second are produced to operate (4) conventional steam turbine generators.

Success in reaching the goal of electric power production using IFE is complicated by a great number of concerns that reach far beyond the laser driver. One is the cost of the power produced. Using the same kind of calculations that are used to model the NIF and Nova lasers, we predicted that electricity produced by ICF would cost about 8.6 cents per kilowatt-hour.<sup>4</sup> While this is higher than the cost of power produced today by fossil fuels (5 to 6 cents per kilowatt-hour), future energy costs from traditional nonrenewable sources are uncertain.

The highest risk issues confronting the prospect of ICF-based power generation are the level of achievable target gain and the survivability of the final optic. One of the primary missions of NIF is to attain sufficient target gain to produce ignition. The final optic plays a critical role because this material must efficiently transmit ultraviolet light while simultaneously incurring the wrath of the high-energy neutrons and gamma rays that emanate from the target and the target chamber.

The best prospect for the final optic is heated fused silica. Although the rates at which the final optic will be bombarded by radiation in NIF are significantly less than those for inertial fusion energy (about 50 kilorads per year versus 50 kilorads per second!), the basic physical mechanisms may be similar. Figure 7 shows that different types of fused silica have significantly different levels of radiation-hardness, as indicated by the blackening of the

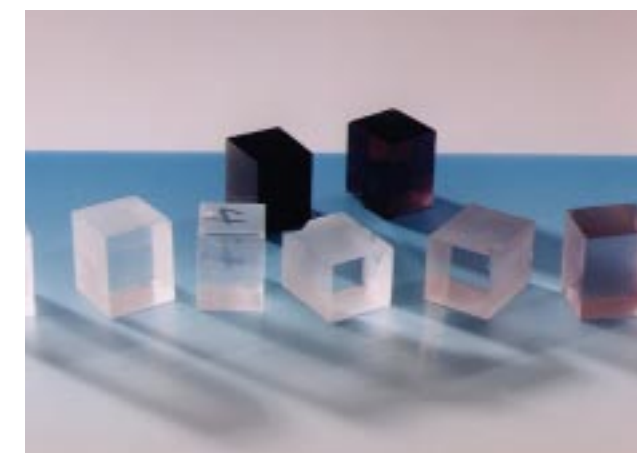
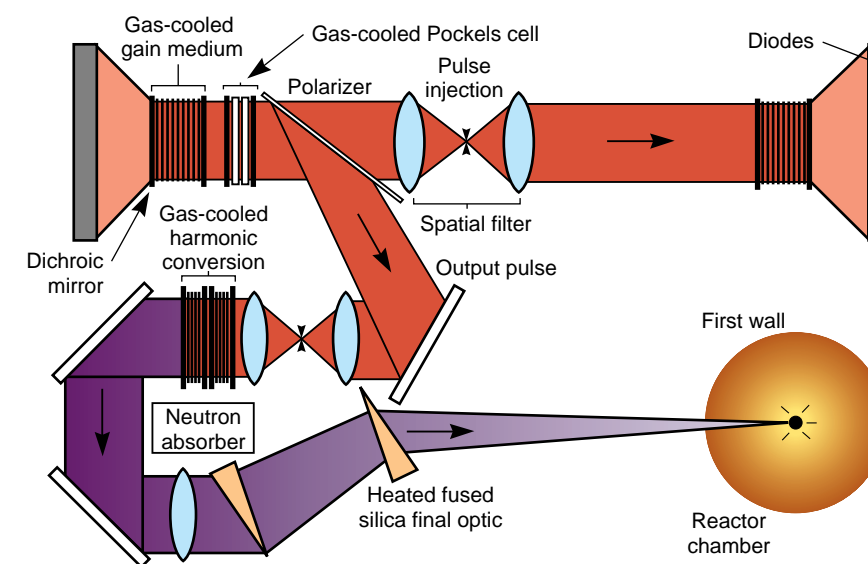

**Figure 7.** Picture of various fused silica samples that received radiation doses comparable to those predicted for the final optic at the National Ignition Facility. On the basis of our studies, the appropriate "radiation-hard" optical materials were identified.

material. This blackening can be avoided easily, however, by choosing fused silica materials that are free of aluminum impurities. Our investigation also revealed that germanium impurities also reduce radiation hardness.

After determining that certain fused silicas had neither aluminum nor germanium impurities, we identified the intrinsic defects that were created solely by the neutrons and gamma rays. Our

light absorption measurements indicate that, if the appropriate type of fused silica is used, the absorption loss at the NIF laser wavelength of 0.35 micrometers will be 1% after 30 years of operation, which is the life expectancy of NIF. In another series of experiments, we determined that defects that are formed by the neutrons and gamma rays are annealed, or repaired, if the



**Figure 8.** Schematic of a beamline designed on the basis of laser physics, achievable performance specifications, and reasonable cost. The basic architecture involves a multipass amplifier and frequency conversion (as does the National Ignition Facility), as well as the technology enhancements discussed in this article.

## Many Uses for Diode-Pumped Solid-State Lasers

Diode-pumped solid-state lasers are a rapidly emerging technology that is likely to have broad impact in many areas throughout industry, government, and the military. In addition to inertial confinement fusion, our laser science and technology team is currently developing diode-pumped solid-state lasers for materials processing, x-ray lithography, medical surgery, position calibration, remote sensing, and other purposes. These are specialty lasers that have required the deployment of uncommon laser materials and unique architectures. For example, the laser in the picture at the right is a high-power, 2.01-micrometer thulium-doped yttrium–aluminum–garnet (Tm:YAG) laser capable of delivering more than 100 watts, a power level nearly ten times greater than that previously possible. Its power and compact size are in part based on the use of a lens duct\* that collects and funnels the light output of the laser diode array into the Tm:YAG gain medium. The photograph shows the specialized laser diode array packages used in the laser, including the microchannel cooling technique and the microlens conditioned output of the individual packages.

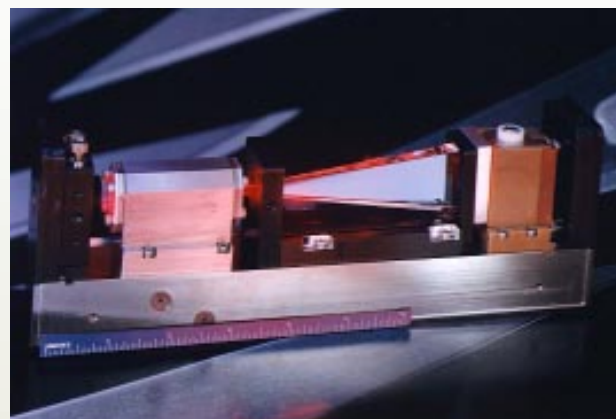

Alternative example of diode-pumped solid-state laser development pursued by the research team. Developed at Livermore by Eric Honea and his collaborators, this laser, with a 2-micrometer thulium-doped yttrium–aluminum–garnet laser head, achieved power levels nearly ten times greater than those previously possible.

\* "A Light Funnel for Diode-Pumped, Solid-State Lasers," *Science & Technology Review*, UCRL-52000-95-11/12 (November/December 1995), pp. 26-27.

optic is held at an elevated temperature. At 400°C, the defects should not cause undue absorption of the laser light—even at the radiation dose rate predicted for a power plant.

The beamline for a fusion power plant, including the heated fused silica final optic, is shown schematically in Figure 8. It is similar to the prototype beamline of NIF in that a pulse (about 1.7 joules) is injected and then allowed to traverse the multipass amplifier four times before being ejected at about 10 kilojoules. However, the higher gain and energy storage possible with diode pumping and Yb:S-FAP gain crystals eventually will allow for better reliability, beam quality, compactness, and efficiency, all of which are necessary in a power plant. This beamline is considered capable of an

efficiency approaching 10% for on-target properly conditioned laser light, a level upon which the feasibility of a working power plant critically depends. Figure 8 also depicts the gas cooling of the laser crystals and the harmonic conversion crystals (which nonlinearly convert the 1.047-micrometer fundamental output wavelength of the laser to the third harmonic at 0.35 micrometers). Both technologies together with the heated fused silica final optic are fundamental to producing electricity based on laser fusion. When 5,175 beamlets are grouped in 345 beamlines, the system could deliver 3.7 megajoules on-target. An assumed target gain of 76 would lead to gross energy production of 300 megajoules with 40 megajoules per shot recycled to power the laser and

other systems.<sup>3</sup>

## To and beyond Ignition

While the flashlamp-pump technology of NIF will achieve ignition and be used to explore weapons issues during the beginning of the next century, diode-pumped solid-state lasers represent a promising laser driver beyond NIF. Other fusion driver options exist with the potential of effecting fusion energy production—the heavy-ion accelerator is one example; light-ion accelerators and krypton–fluoride lasers are others.<sup>1</sup> And each has complementary risks and benefits for fusion energy production.<sup>9</sup> At this juncture, however, many physics and engineering issues need to be resolved for any option. The applicability of these

options to driving targets will become clearer during the next decade. The promise of fusion for energy production and the relative utility of different driver options is best left as an open question until after NIF ignites a target. Yet the diode-pumped option is certainly a major contender as the vehicle for the ultimate application of NIF technology—the production of unlimited electrical power from inertial confinement fusion.

In the near-term, uses for advanced high-repetition-rate lasers also abound. In addition to offering us a pathway to future inertial fusion studies and stockpile stewardship applications, our small-scale experiments attest to the scientific viability of diode-pumped solid-state lasers for fusion, as do the synergistic laser development efforts in support of numerous military and civilian applications (see the box on p. 10).

**Key Words:** diode-pumped solid-state lasers, final optic, gas-cooled slab (GCS), gain medium, inertial confinement fusion (ICF), inertial fusion energy (IFE).

## References

1. "The Role of NIF in Developing Inertial Fusion Energy," *Energy & Technology Review*, UCRL-52000-94-12 (December 1994), pp. 30–42.
2. "Keeping the Nuclear Stockpile Safe, Secure, and Reliable," *Science & Technology Review*, UCRL-52000-96-8 (August 1996), pp. 6–15.
3. "The National Ignition Facility: An Overview," *Energy & Technology Review*, UCRL-52000-94-12 (December 1994), pp. 1–6.
4. C. D. Orth, S. A. Payne, and W. F. Krupke, "A Diode-Pumped Solid-State Laser Driver for Inertial Fusion Energy," *Nuclear Fusion* **36**, 75–116 (1996).
5. S. A. Payne, *et al.*, "Gain Medium for Laser-Driven Inertial Fusion Energy," *Inertial Confinement Fusion Quarterly Report* **2**, 51–59 (1992), UCRL-LR-105821-92-2.
6. S. B. Sutton, G. F. Albrecht, and H. F.

Robey, "Heat Removal in a Gas-Cooled Solid-State Laser Disk Amplifier," *AIAA Journal* **30**, 431–435 (1992).

7. C. D. Marshall, *et al.*, "Diode-Pumped Gas-Cooled-Slab Laser Performance," *Proceedings of Advanced Solid State Lasers Conference* (Optical Society of America, Washington, D.C., 1996).
8. C. D. Marshall, *et al.*, "Diode-Pumped Ytterbium-Doped Sr<sub>5</sub>(PO<sub>4</sub>)<sub>3</sub>F Laser Performance," to be published in *IEEE Journal of Quantum Electronics* **32** (1996).

9. W. R. Meier and L. M. Waganer, "Recent Heavy-Ion Fusion Power Plant Studies in the U.S.," *Il Nuovo Cimento* **106A**, 1983–1995 (1993).

**For further information contact Stephen Payne (510) 423-0570 (payne3@llnl.gov) or Christopher Marshall (510) 422-9781 (cmarshall@llnl.gov).**

## About the Scientists



STEPHEN PAYNE, one of the primary contributors to this article, joined the Laser Programs when he came to the Laboratory in 1985. Since 1995 he has been the Associate Program Leader responsible for the Advanced Lasers and Components element of the Laser Science and Technology Program. He has co-authored more than 100 scientific papers on spectroscopy and laser physics. Payne received his B.S. in chemistry from the State University of New York at Binghamton in 1978 and a Ph.D. in chemistry from Princeton University in 1983. From 1983 to 1985 he was a post-doctoral fellow at the University of Pennsylvania.



CHRISTOPHER MARSHALL, the other primary contributor, came to the Laboratory in 1992 as a member of the Laser Programs. He is the Project Leader responsible for developing advanced diode-pumped lasers for inertial confinement fusion and has co-authored more than 20 scientific papers on laser physics and materials since coming to the Laboratory. Marshall received his B.S. in physical chemistry from Rensselaer Polytechnic Institute in Troy, New York, in 1987 and a Ph.D. in chemical physics from Stanford University in 1992.

Other colleagues who contributed to this article include: Bill Krupke, who proposed the idea of using diode-pumped solid-state lasers for fusion energy; Howard Powell, who provided technical management and guidance; Grant Logan, who gave advice concerning the development pathway; Lloyd Chase and his associates, who introduced the heated fused silica concept; Charles Orth, who executed the power plant study; and the many members of the Advanced Lasers and Components Team who developed the diodes, laser crystals, lens ducts, gas cooling, and other components used in this work.

# JUMPIN' JUPITER!

## Metallic Hydrogen

*A 1935 theory predicted that hydrogen becomes metallic when enormously intense pressure is applied. But the theory remained unproved for some 60 years until a Lawrence Livermore team tried a “shocking” idea.*

The Laboratory's two-stage light-gas gun was instrumental in the shock compression experiments that metallized hydrogen.



**H**YDROGEN is the simplest and most abundant of elements. Composed of one proton and one electron, it makes up 90% of our universe (by number of atoms). On Earth, hydrogen is commonly found as a diatomic molecular gas. But on Jupiter, where interior pressure is millions of times greater than that at our planet's surface, the hydrogen molecule is theorized to exist as a superhot liquid metal.

The theory that hydrogen turns metallic under extreme pressure was first advanced in 1935 by Eugene Wigner, who would go on to win a 1963 Nobel Prize in physics for his work in quantum mechanics. Finding experimental evidence of Wigner's hydrogen metallization theory, however, has proven to be extremely difficult for the scientific community. While studies of the universe's lightest material led to discovery of hydrogen's solid and liquid phases, metallic hydrogen remained out of reach—until recently.<sup>1</sup>

At Lawrence Livermore National Laboratory, in a series of shock compression experiments funded by Laboratory Directed Research and Development grants, we successfully ended a 60-year search for hard evidence of metallic hydrogen and the precise pressure at which metallization occurs at a particular temperature.

Our success in metallizing hydrogen would not have been achieved without the shock-wave technology built up over more than two decades to support Lawrence Livermore's nuclear weapons program. It represents the integration of the Laboratory's broad capabilities and expertise in gas-gun technology, shock physics, target diagnostics, hydrodynamic computational simulations, cryogenics, and hydrogen and condensed-matter physics.

Knowing what happens when matter, such as hydrogen, encounters enormously high pressure and temperature is critical for the success of the Laboratory's research in areas relevant to our science-based stockpile stewardship mission, such as nuclear explosives, conventional high

explosives, and laser fusion, as well as for our collaborative efforts in planetary science research. For more than two decades, we have been helping improve that understanding through shock-compression studies using our two-stage light-gas gun (see the [box on p. 15](#)).

The gas gun permits us to fire hypervelocity projectiles into highly instrumented targets ([Figure 1](#)), shocking matter to extreme conditions for a millionth of a second or less. These experiments create pressures of a million-plus atmospheres, temperatures up to thousands of degrees depending upon the material being shocked, and densities several times that of a material's solid state.

In addition to hydrogen, we have performed shock compression experiments on other liquefied gases such as nitrogen, water, carbon dioxide, oxygen, carbon monoxide, deuterium (an isotope of hydrogen), helium, and argon, and on solids such as aluminum, copper, tantalum, and carbon (graphite). Data from such experiments are used to determine a material's equation of state (EOS expresses the relationship between pressure, density, and temperature), to validate theories, and to generate reliable computational models of a material's behavior under a wide range of thermodynamic variables.

### Quest for Metallic Hydrogen

Under normal conditions on our planet, molecular hydrogen functions as an insulator, blocking electrical flow. Apply sufficient pressure, theory said, and hydrogen turns metallic, becoming an exceptional conductor of electricity. Theory predicted that metallization would occur when the insulating molecular solid would transform to a metallic monatomic solid at absolute zero—0 degrees kelvin (K) or -460°F. For early metallic hydrogen theorists, “sufficient pressure” was thought to be 0.2 megabars (1 bar is atmospheric pressure at sea level; a megabar, or Mbar, is a million times atmospheric pressure at sea level). Subsequent predictions pushed

metallization pressure to as high as 20 Mbar. At the time our experiments were conducted, the prevailing theory predicted 3 Mbar for solid hydrogen at 0 K.

For 35 years after Wigner proposed his theory, studies on metallic hydrogen were relegated to the theoretical realm because there was no way to approach the subject experimentally. By the 1970s, however, the tools of science had reached a point where it became possible to construct experiments aimed at creating conditions that theory said were required for metallization. At Lawrence Livermore, for example, one research approach<sup>2</sup> used an explosively driven system that compressed a magnetic field and, in turn, a small sample of hydrogen to megabar pressures without shocking the hydrogen, and thus the temperature of the sample was kept very low. The early Livermore experiments generated pressures similar to those we recently reached (about 2 Mbar). While electrical conductivity was measured, the approach did not provide necessary evidence of metallization; the measurement system was only sensitive to conductivity values much less than that of a metal.

In recent years, researchers at other laboratories have attempted to achieve metallization by crushing micrometer-sized samples of crystalline hydrogen in a diamond anvil cell. This small mechanical press creates very high pressures in a nanogram-sized sample when the small flat faces of two flawless diamonds are forced together, exerting megabar pressure on the sample trapped between them.<sup>3</sup> While diamond anvil studies of hydrogen resulted in an initial claim of optical evidence for metallization, this claim was later found to not hold up.<sup>4</sup> Significantly, there was no establishment of metallic character using optical probes. Metallic character is most directly established by electrical conductivity measurements, which are not yet possible in diamond anvil cells with hydrogen samples at any pressure.



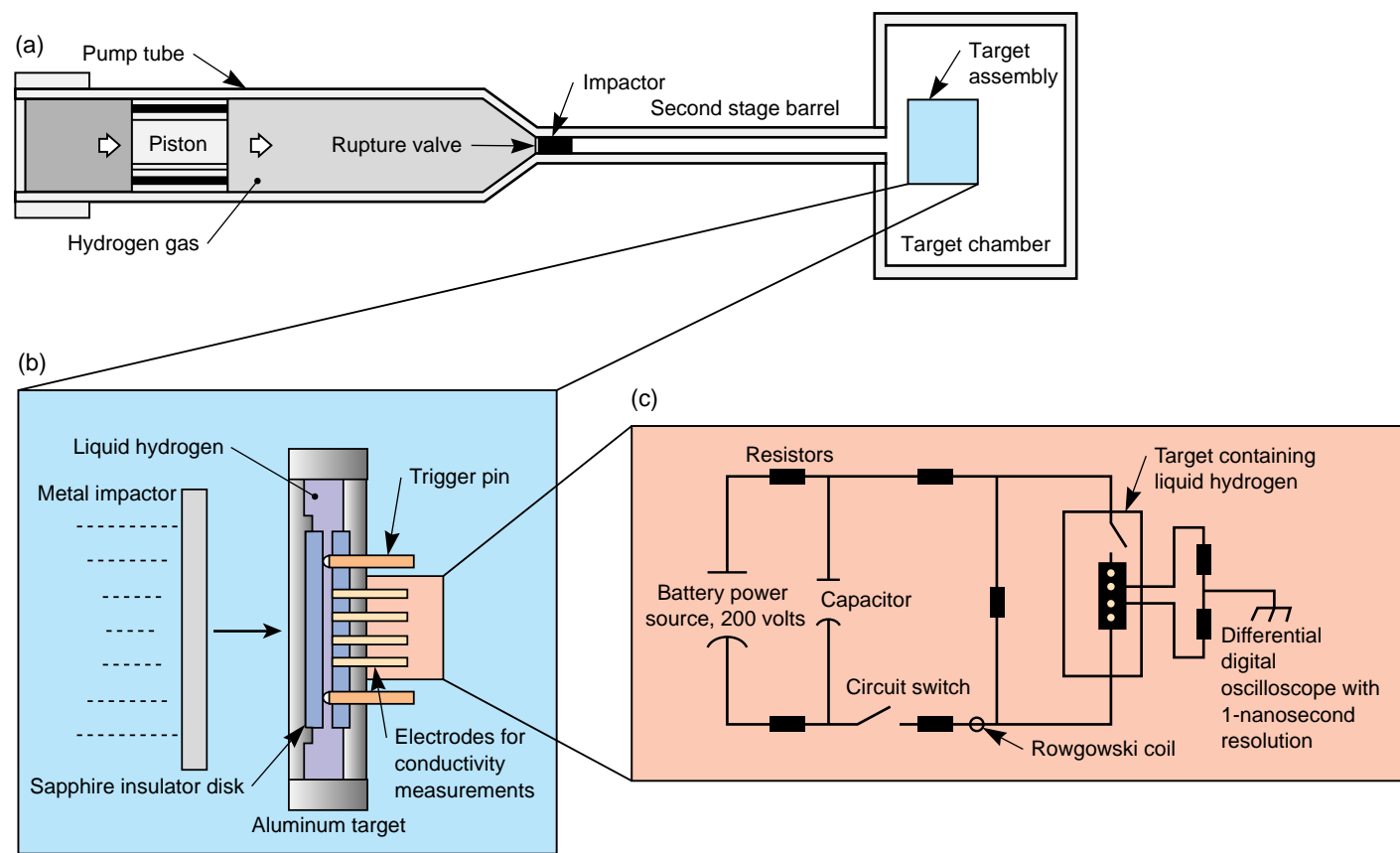

**Figure 1.** Our success in metallizing hydrogen came during a series of experiments to understand the electrical properties of shocked liquid hydrogen. (a) Our two-stage light-gas gun accelerates plastic-encased aluminum and copper impactor plates to velocities of up to 8 kilometers per second (18,000 mph), sending a shock wave into (b) the target assembly containing a 0.5-millimeter-thick sample of liquid hydrogen. Electrical resistivity/conductivity is measured using (c) a four-probe constant-current circuit. Trigger pins turn on the data-recording equipment when hit by the initial shock wave, and a Rowgowski coil measures current. The circuit is connected to a differential digital oscilloscope, which instantaneously records the electrical quantities during the test.

**Our Approach**

In 1991, we began a series of experiments to determine how compression affected the electrical properties of diatomic or molecular hydrogen and deuterium both of which are insulators at ambient temperatures and pressures. Our specific objective was to advance fundamental understanding of the way hydrogen transitions from an insulator to a conductor at shock-test pressures and temperatures. Evidence of actual metallization was an unanticipated result of our experiments. It was unexpected for several reasons: (1) we used liquid hydrogen, rather than solid hydrogen that conventional wisdom indicated was required; (2) we applied a methodology—shock compression—that had never before been tried in order to metallize hydrogen; and (3) we were working at higher

temperatures (3,000 K) than metallization theory specified. For our experiments, we used liquid hydrogen at an initial temperature of 20 K (-423°F) because: (1) it is easier to liquefy hydrogen than it is to solidify it in our experiments, (2) shock compression dramatically increases temperatures and turns solid hydrogen into liquid, so it made sense to begin with a liquid, and (3) only fluid hydrogen, not solid, is present in high-pressure and high-temperature systems that matter to the “real world”—in superhot, hydrogen-rich planets like Jupiter and Saturn and in fusion energy experiments like those conducted at Livermore where laser beams compress tiny spherical targets of liquid deuterium and tritium, both isotopic forms of hydrogen. As in any shock-wave experiment involving liquids, we confined the liquid hydrogen (or in some cases liquid

**How Our Gas Gun Works**

Our shock compression studies use a 20-meter-long, two-stage light-gas gun built by General Motors in the mid-1960s for ballistic missile studies; the gun has been in operation at the Laboratory since 1972. The gun consists of a first-stage breech containing up to 3.5 kilograms of gunpowder and a pump tube filled with 60 grams of hydrogen, helium, or nitrogen gas; and a second-stage evacuated barrel for guiding the high-velocity impactor to its target. Hot gases from the burning gunpowder drive a heavy (4.5- to 6.8-kilograms) piston down the pump tube, compressing the gas. At sufficiently high pressures, the gas eventually breaks a rupture valve and enters the narrow barrel, propelling a 20-gram impactor housed in the barrel toward the target. When the impactor hits the target, it produces a high-pressure shock wave. In a fraction of a microsecond, the

shock wave reverberates through the target. Diagnostic equipment, triggered by the initial wave, measures the properties of the shocked material inside the target during this extremely brief period. Projectile velocity can range from 1 to 8 kilometers per second (up to 18,000 mph). The preferred velocity is achieved by selecting the appropriate type and amount of gunpowder, driving gas (hydrogen for velocities at or above 4 kilometers per second, helium and nitrogen for lower velocities), pressure required to open the rupture valve, diameter of the barrel, and the metal and mass of the impactor. The velocity of the shock wave, when combined with the initial conditions (impactor velocity, known densities, equation of state of the projectile and target materials) yields a precise measure of the pressure, density, and energy attained.

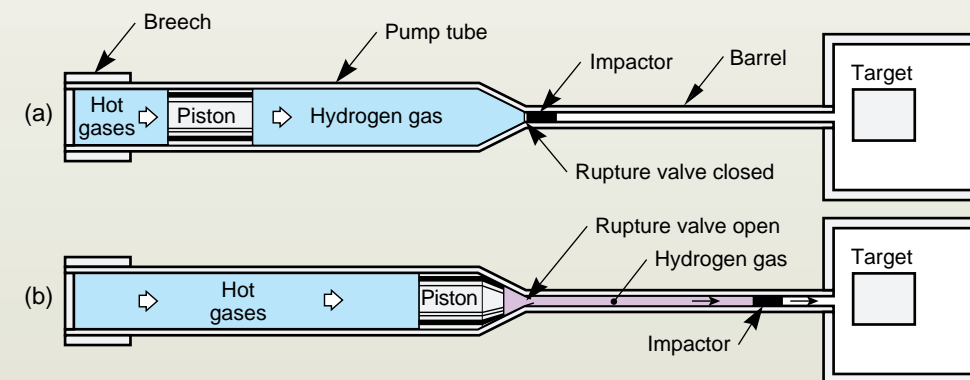

(a) In the first stage of the gas gun (blue shading), hot-burning gases from gunpowder drive a piston, which in turn compresses hydrogen gas. (b) In the second stage (pink shading), the high-pressure gas eventually ruptures a second-stage valve, accelerating the impactor down the barrel toward its target.

deuterium) in a suitable target container that separated it from the vacuum of the target chamber. (Refer to Figure 1b.) The target walls had the required flat impact surface and were made of a material for which we have an accurate equation of state (aluminum) so that we could compute the pressures, densities, and temperatures reached during the experiments. The liquid hydrogen (or deuterium) was a half millimeter thick, and the target was cryogenically cooled. We sandwiched the target between two single-crystal sapphire anvils that provide stiffness and electrical

insulation for the four steel electrodes implanted at the surface of the liquid hydrogen inside the target. These electrodes are used to measure the changes in the sample’s electrical resistivity/conductivity during shock tests. Two of the electrodes introduce current to the inertially confined hydrogen sample, and two measure voltage across the sample. A trigger pin in the target produces an electrical signal when struck by the initial shock wave, turning on the data recording system (Figure 1c) at the proper moment. The conductivity of the

shocked hydrogen is thus measured before the pressure wave reaches any external surface, that is, before the sample holder blows up when the shock reaches its external surface. We mounted the anvils on aluminum plates that serve as the front and rear walls of the target, initially at 20 K. At that low temperature, the aluminum remains strong and ductile. Finally, we carefully wrapped the target with 50 layers of aluminized mylar to reduce the heat losses that would boil away the liquid hydrogen and cause our sample to literally

disappear. The impactors aimed at these target samples were made of aluminum and copper embedded in plastic.

Using these impactors in the gas gun, we shocked the hydrogen samples to pressures ranging from 0.9 to 1.8 Mbar and temperatures from 2,000 to 4,000 K. We designed our conductivity experiments to consist of an initial weak shock in the hydrogen followed by a series of very weak shocks reverberating between sapphire anvils, between which our hydrogen sample was sandwiched. In this way, the temperature was kept about ten times lower than it would be for a single sharp shock to the same final pressure. Each data point we recorded using the diagnostics illustrated in Figure 1c represents a measurement taken in about one ten-millionth of a second, which is more than sufficient for the sample to come into equilibrium, that is, reach a stable pressure, density, and temperature. Electrical signal levels of a few hundredths of a volt and currents of about 1 ampere lasted about 200 nanoseconds ( $200 \times 10^{-9}$  seconds), indicating that, indeed, metallization had occurred.

### Our Results

As shown in Figure 2, we found that from 0.9 to 1.4 Mbar, resistivity in the shocked fluid decreases almost four orders of magnitude (i.e., conductivity increases); from 1.4 to 1.8 Mbar, resistivity is essentially constant at a value typical of that of liquid metals. Our data indicate a continuous transition from a semiconducting to metallic diatomic fluid at 1.4 Mbar, nine-fold compression of initial liquid density, and 3,000 K.

Some theorists have speculated that metallic hydrogen produced under laboratory conditions might remain in that state after the enormous pressures required to create it are removed. However, metallization in our experiments occurred for such a brief period of time, and in such a manner, that questions about hydrogen's superconducting properties and retention of metallic form could not be answered.

At the relatively low temperature, the fluid hydrogen remained almost essentially molecular, rather than breaking into individual atoms. As a

result, electrons in the sample freely flowed from molecule to molecule in a fashion that is characteristic of metals. At metallization, we calculate that only about 5% of the original molecules have separated into individual atoms of hydrogen, which means that our metallic hydrogen is primarily a molecular fluid. (Observation of this molecular metallic state in our experiments was unexpected. Only the monatomic metallic state was predicted by theory.)

In looking at the insulator-to-metal transition, we focused on the changes in electronic energy band-gap (measured in electron volts) in hydrogen under shock compression. The value of the electronic band-gap is the energy that must be absorbed by an electron in order for it to contribute to electrical conduction. A zero band-gap is characteristic of a metal; a positive, nonzero band-gap is characteristic of an insulator. Thus, the magnitude of the band-gap of an insulator is a measure of how far away the insulator is from being a metal.

At ambient pressure, condensed molecular hydrogen has a wide band-gap (about 15 electron volts), making it a

transparent insulator, like glass. Theory said that when hydrogen is squeezed by tremendous pressure, the gap would close to zero (the band-gap of metals, which are nontransparent conductors). Our studies show that when shocked multiple times in a very cold liquid state, hydrogen becomes first a semiconductor and then a fluid metal when, as its density increases, its temperature becomes equal to the band-gap at about 0.3 electron volts (Figure 3). At this point, all the electrons that can be excited by the shock to conduct electricity have been excited. Insensitive to further decreases in band-gap, the conductivity stops changing. Our conductivity data for hydrogen are essentially the same as those for the liquid metals cesium and rubidium at 2,000 K undergoing the same transition from a semiconducting to metallic fluid. The comparison is shown in Figure 4.

### Implications/Future Research

Our gas-gun experiments enhance collective knowledge about the interiors of giant planets. Our earlier studies of

temperature measurements of shock-compressed liquid hydrogen led us to conclude that Jupiter's molecular envelope is cooler and has much less temperature variation than previously believed. Further interpretation of those data suggests that there may be no distinct boundary between Jupiter's core and mantle, as there is on Earth.<sup>6</sup>

Jupiter, which is almost 90% hydrogen, is not the only planet rich in metallic hydrogen. Hot metallic hydrogen is believed to make up the interior of Saturn and may be present in other large planets discovered recently outside our solar system. The presence of metallic hydrogen in these planets has a pronounced effect on their behavior. On Jupiter, given its extreme internal pressures, the bulk of hydrogen is most likely in the fluid metallic state; in fact, given the pressure at which hydrogen metallizes, much more metallic hydrogen—the equivalent of 50 times the mass of Earth—exists in Jupiter than previously believed. We also assume this metallic hydrogen is the source of Jupiter's very strong magnetic field, the largest of any planet in our solar system.

The results of our experiments lend credence to the theory that Jupiter's magnetic field is produced not in the core, but close to the Jovian surface (Figure 5). Based on our data, it appears that the band of conductivity producing the magnetic field is much closer to the planet's surface than was thought to be the case.<sup>7</sup>

We anticipate that laser fusion scientists, who use the compressibility of hydrogen to tune laser pulses, also will find the results of our metallic hydrogen experiments extremely useful. Our experiments provide new insight into the behavior of deuterium and tritium, isotopic forms of hydrogen used in laser fusion targets. Higher fusion-energy yields could result from an improved understanding of the temperature–pressure relationship in hydrogen and its isotopes. Indeed, our hydrogen metallization studies suggest strongly that the revised computation of the equation of state of hydrogen at intense pressures will help in perfecting the hydrogen-isotope-filled targets being designed for the National Ignition Facility, making their performance range broader and more flexible. This is also encouraging news for the science-based

**Figure 2.** As shock compression increases pressure, liquid molecular hydrogen's electrical resistivity falls dramatically, a decrease of almost four orders of magnitude from 0.9 to 1.4 megabars before plateauing between 1.4 and 1.8 megabars where resistivity (and conversely, conductivity) is essentially constant at a value typical of that of a liquid metal. Our experiments used molecular hydrogen and deuterium, which have different densities.

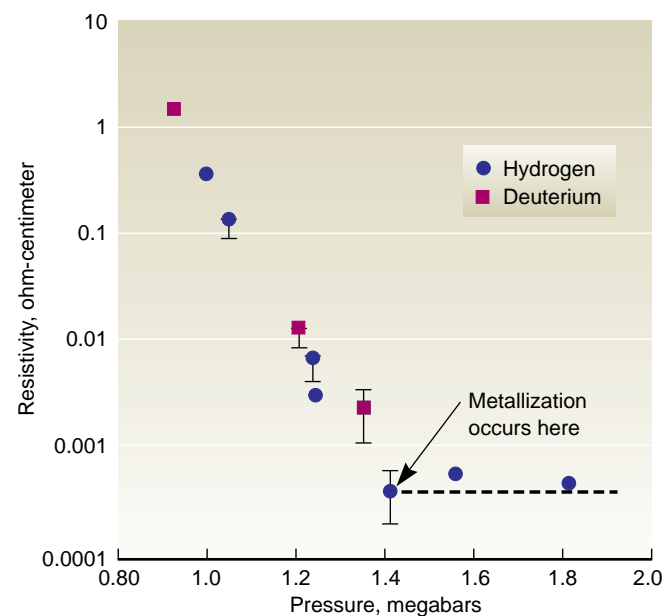

**Figure 3.** We examined electronic band-gap changes as molecular hydrogen makes the transition from insulator to conductor. At ambient pressure, condensed molecular hydrogen has an electronic energy band-gap of 15 electron volts (eV), making it an excellent insulator. In previous single-shot shock compression experiments (at up to 0.2 megabars pressures and 4,600 degrees kelvin), measurements yielded an energy gap of 11.7 eV.<sup>5</sup> The results of our new shock compression studies (shown by the solid part of the curve) indicate that molecular hydrogen becomes metallized when the band-gap is reduced to about 0.3 eV.

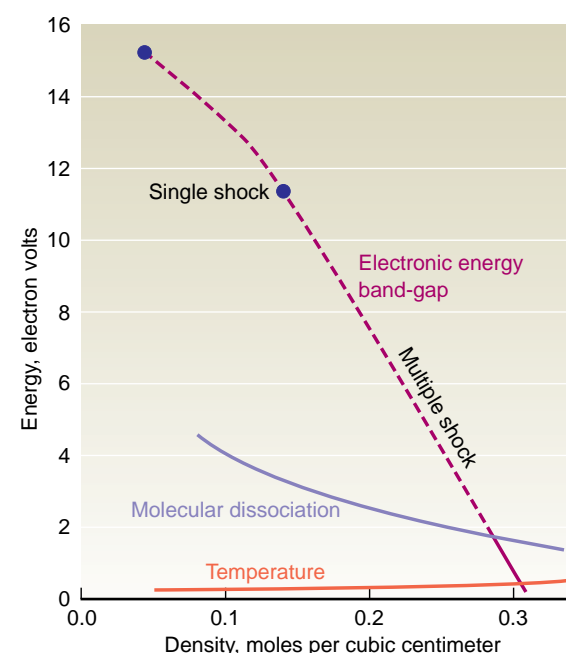

**Figure 4.** At 2,000 degrees kelvin, conductivity for hydrogen is about the same as that of the metals cesium and rubidium. Liquid molecular hydrogen becomes conducting at a higher density than do those metals.

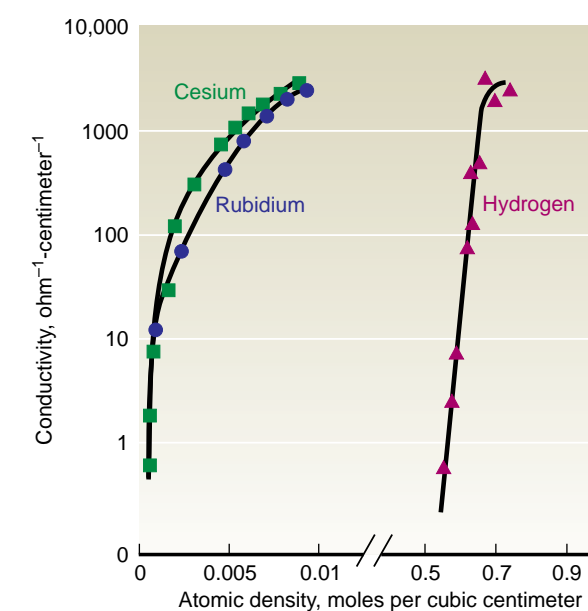

(a) Previous theory

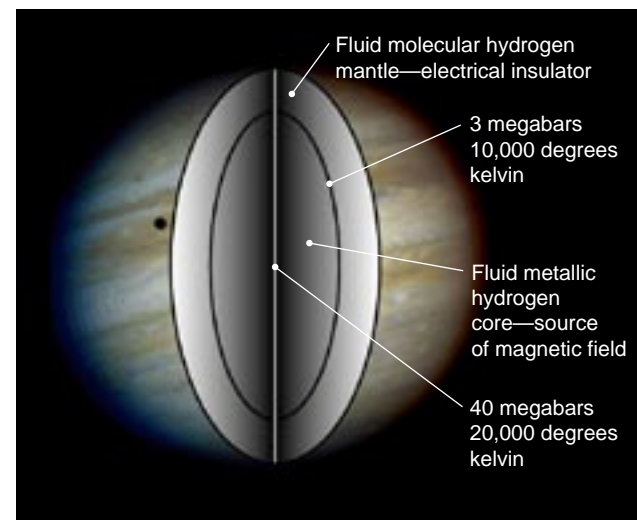

(b) Revised theory

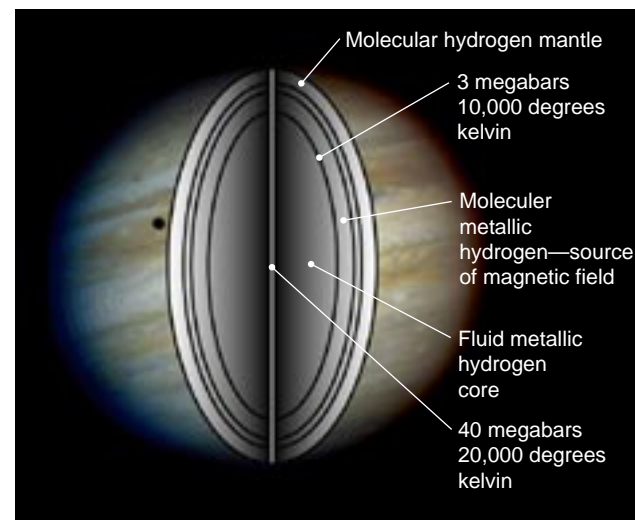

**Figure 5.** Our work has allowed us to calculate the electrical conductivity in the outer region of Jupiter. The planet's magnetic field is caused by convective dynamo motion of electrically conducting metallic hydrogen. Our results indicate that in Jupiter, the magnetic field is produced much closer to the planet's surface (b) than was thought previously (a).

stockpile stewardship research that will eventually be performed on NIF.

Future experiments will focus on (1) using various hydrogen isotopes—molecular hydrogen, deuterium, and hydrogen–deuterium—to determine the temperature dependence of the electronic energy gap, (2) exploring higher pressures up to 3 Mbar, and (3) probing effects in similar liquids such as molecular nitrogen and argon.

**Key Words:** gas gun; hydrogen—fluid, liquid, metallic; Jupiter; National Ignition Facility; shock compression tests; stockpile stewardship.

#### References

1. S. T. Weir, A. C. Mitchell, and W. J. Nellis, "Metallization of Fluid Molecular Hydrogen," *Physical Review Letters* **76**, 1860 (1996).
2. R. S. Hawke, *et al.*, "Observation of Electrical Conductivity of Isentropically Compressed Hydrogen at Mbar Pressures," *Physical Review Letters* **41**, 994 (1978).
3. "The Diamond Anvil Cell: Probing the Behavior of Metals under Ultrahigh Pressures," *Science & Technology*

*Review*, UCRL-52000-3-96 (March 1996), pp. 17–27.

4. R. J. Hemley, *et al.*, "Synchrontron Infrared Spectroscopy to 0.15 eV of H<sub>2</sub> and D<sub>2</sub> at Megabar Pressures," *Physical Review Letters* **76**, 1667 (1996) and H. N. Chen, *et al.*, "Extended Infrared Studies of High Pressure Hydrogen," *Physical Review Letters* **76**, 1663 (1996).
5. W. J. Nellis, *et al.*, "Electronic Energy Gap of Molecular Hydrogen from Electrical Conductivity Measurements at High Shock Pressures," *Physical Review Letters* **68**, 2937 (1992).

6. W. J. Nellis, M. Ross, and N. C. Holmes, "Temperature Measurements of Shock-Compressed Liquid Hydrogen: Implications for the Interior of Jupiter," *Science* **269**, 1249 (1995).
7. W. J. Nellis, S. T. Weir, and A. C. Mitchell, "Metallization and Electrical Conductivity of Hydrogen in Jupiter," *Science* (in press).

**For further information contact**  
William Nellis (510) 422-7200  
(nellis1@llnl.gov).

#### About the Scientist



Physicist WILLIAM NELLIS joined the Laboratory in 1973. His specialty is the investigation of condensed matter both during and after high-pressure shock compression. The highlight of this work is the observation of the metallization of fluid hydrogen at 1.4 megabars pressure and nine-fold compression. He has delivered invited talks at 44 professional conferences since 1979 and is the author or co-author of more than 100 papers. A fellow of the American Physical Society's Division of Condensed Matter Physics, Nellis holds M.S. and Ph.D. degrees in physics from Iowa State University. He received his B.S. in physics from Loyola University of Chicago.

#### Research Highlight

## Modeling Human Joints and Prosthetic Implants

**R**EPETITIVE motion injuries are one of the fastest growing causes of lost time to business and industry, not to mention their impact on worker health and morale. The orthopedic surgery these injuries sometimes necessitate is costly and painful. The therapy and orthopedic implants associated with degenerative bone and muscle diseases and acute injuries are also costly, and in the case of implants, the initial cost may not be the final cost if and when the implant needs to be replaced.

Computational models of joint anatomy and function can help doctors and physical therapists understand trauma from repetitive stress, degenerative diseases such as osteoarthritis, and acute injuries. Models of prosthetic joint implants can provide surgeons and biomechanical engineers with the analytical tools to improve the life-span of implants and increase patient comfort.<sup>1</sup>

With such purposes in mind, the Laboratory embarked about three years ago on a mission to model the whole human hand at high resolution. The challenge is that most biological structures are dauntingly complex, and the hand is no exception. The human wrist alone has eight bones, and the rest of the hand has 19 more, to say nothing of soft tissues—ligaments, tendons, muscles, and nerves—and the interactions among them.

More recently, the Laboratory's Computational Biomechanics Group within the Institute for Scientific Computing Research (ISCR) narrowed the mission to a computational model focusing on the dynamics of specific bones and joints that are often associated with injury or damage. The group also undertook a closely related endeavor: creating a computational model of prosthetic joint implants, initially for the thumb.

In light of the complexity of these models and the need for very high accuracy, it is appropriate that a facility like LLNL—which offers powerful computational resources, an understanding of complex engineering systems, and multidisciplinary expertise—take on these tasks. It is also significant that the work is being done collaboratively through the ISCR and draws on experts from the Laboratory (particularly the Mechanical Engineering Department), academia, medicine, and industry (see the box on p. 20). The

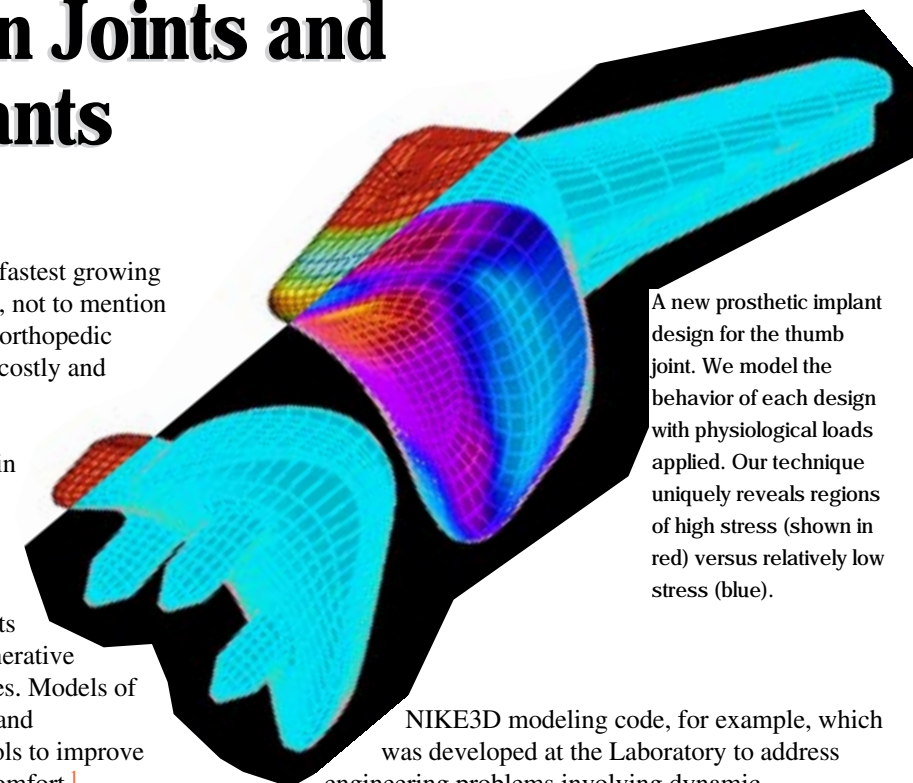

A new prosthetic implant design for the thumb joint. We model the behavior of each design with physiological loads applied. Our technique uniquely reveals regions of high stress (shown in red) versus relatively low stress (blue).

NIKE3D modeling code, for example, which was developed at the Laboratory to address engineering problems involving dynamic deformations, such as the response of bridges to large earthquakes,<sup>2</sup> is now being used as part of our collaborative joint modeling work.

Each person's bones differ in shape and size. Our models are based on the detailed anatomy of individual people. We start with high-resolution data obtained from computed tomography or magnetic resonance imaging, as shown in the illustrations on pp. 20–21. Images from a single hand scan involve several gigabytes of raw data, and the models developed from them are highly complex—thus the need for powerful computers.

#### Focusing on the Hand and Knee

We focused our initial attention on a few joints in the hand. One joint of considerable clinical interest is the thumb carpometacarpal (CMC) joint, which connects the long bone at the base of the thumb with the wrist. During routine grasping activities, CMC joint surfaces are subjected to total forces greater than 200 kilograms (440 pounds), so it is not surprising that injuries are common. The thumb is also often involved in repetitive motion injuries, and the CMC joint is the structure most affected in osteoarthritis, which strikes 8% of the U.S. population. Other joints of considerable interest are the knee and the proximal interphalangeal joint and the metacarpophalangeal joint in the index finger, which have some of the strongest ligaments in the hand.

Previous analyses of joint function (for example, rigid-body kinematic analyses) have typically provided less information than is possible through finite-element methods. On the other hand, most finite-element analyses of biological systems have been linear and two dimensional. We are applying three-dimensional, nonlinear, finite-element codes that assign material properties to bone and the soft-tissue structures associated with joints.

For example, using the NIKE3D modeling code to look at biological problems for the first time, we can model bones as materials that are more rigid than tendons, but less rigid than a metal implant. Soft tissues are inhomogeneous, undergo

deformation, and some show elastic behavior. Our methods simulate tissue behavior under various loads, and joint movement with and without prosthetic implants, and they can assess injury following trauma, such as that caused by a car crash. Because we can assign different material properties to the tissues and examine a range of loads that are experienced in real life, our methods allow us to see interactions between tissue types for the first time, and we can identify regions of high stress. Our high-quality visualizations, such as the one shown in the illustration on p. 19, display complex results in easy-to-understand form.

Two main issues are the computer time needed to run a finite-element code and the labor needed to develop a model from each new scanned data set. We are addressing the first problem by working on powerful supercomputers and by preliminary research in partitioning biological finite-element models to run on massively parallel machines.<sup>3</sup> To address the second problem, we are automating as much of the modeling process as possible.

**Other 3D Visualization Tools**

We are also designing three-dimensional computational tools to interactively move tissues so we can simulate surgical procedures. In the future, we plan to extend our modeling to include additional joints and perhaps internal organs, such as the heart, lungs, and liver.

How can our computational tool benefit the clinical community and ordinary individuals? Our models provide data on internal joint stresses and strains that are not otherwise obtainable. They can be used by surgeons to help plan treatment and to assess outcome following a traumatic or repetitive motion injury. They can help a surgeon predict results, such as strength, range of motion, and other indicators of function after an operation.

Orthopedic implants are a multibillion-dollar U.S. and worldwide industry; however, today's prosthetic joint implants have high failure rates. They often loosen, wear, and fail before the end of a recipient's life, necessitating painful and costly replacement. Orthopedic implants last on average

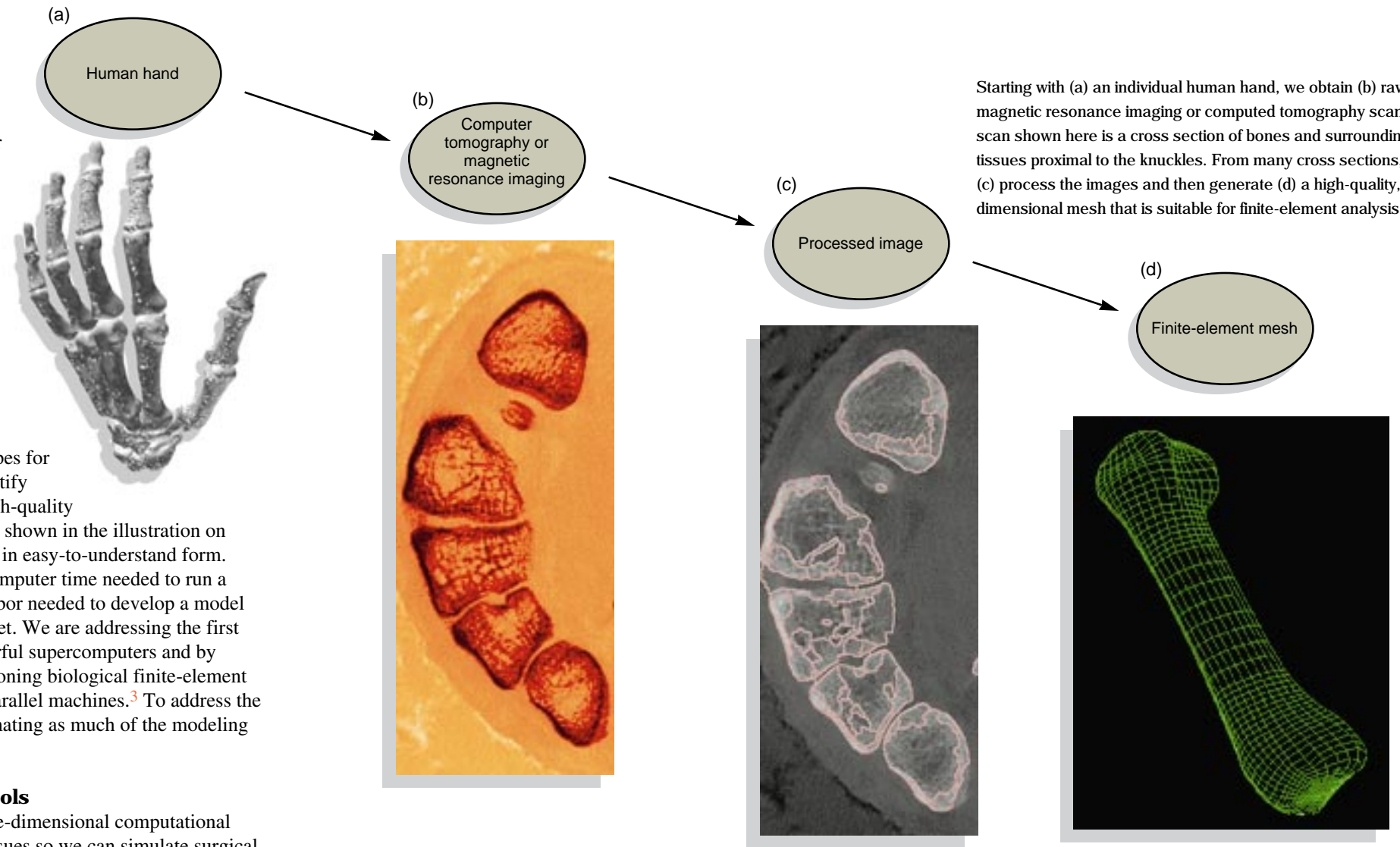

Starting with (a) an individual human hand, we obtain (b) raw magnetic resonance imaging or computed tomography scans. The scan shown here is a cross section of bones and surrounding tissues proximal to the knuckles. From many cross sections, we (c) process the images and then generate (d) a high-quality, three-dimensional mesh that is suitable for finite-element analysis.

5 to 15 years. The initial implant can cost about \$20,000; revision implants are more expensive. Our methods can eventually be applied to any human joint for which prosthetic implants have been designed. Our models are leading to better designs for prosthetic implants, resulting in longer life spans and fewer costly followup operations. Finally, our work can help the automobile industry to develop safety features that will protect against injury to the head, chest, and lower extremities.

**Key Words:** biomechanical modeling, finite-element modeling, Institute for Scientific Computing Research (ISCR), NIKE3D, prosthetic point implants.

**References**

1. *Modeling the Biomechanics of Human Joints and Prosthetic Implants*, UCRL-TB-118601 Rev. 1, Lawrence Livermore National Laboratory, Livermore, CA (1995).
2. *Energy & Technology Review*, UCRL-52000-95-9/10 (September/October 1995) is devoted to a series of articles on computational mechanical modeling, including NIKE3D.
3. For more information on finite-element modeling using massively parallel processors, see "Frontiers of Research in Advanced Computations," *Science & Technology Review*, UCRL-52000-96-7 (July 1996), pp. 4-11.

**For further information contact Karin Hollerbach (510) 422-9111 (hollerbach1@llnl.gov).**

**Collaborators in Biomechanics Modeling**

ISCR biomechanics research is collaborative in the broadest sense. At Livermore, we work with experts in computer vision, mechanical and electrical engineering, nondestructive evaluation, health care technology, health services, and with visiting scholars and students. Partners outside the Laboratory include:

**Academic institutions**

- University of California, Berkeley
- University of California, San Francisco
- University of California, Davis
- University of California, Santa Cruz
- University of New Mexico
- Institute for Math and Computer Science, Hamburg, Germany

**Medical facilities**

- Kaiser Permanente
- G. W. Long Hansen's Disease Center
- Louisiana State University Medical Center
- Massachusetts General Hospital
- Children's Hospital, San Diego

**Industry**

- ArthroMotion/Avanta Orthopedics, Inc.
- ExacTech
- Orthopedic Biomechanics Institute
- National Highway Traffic Safety Administration
- Wright Medical, Inc.
- XYZ Scientific Applications, Inc.
- Zimmer, Inc.

(continued from page 2)

The electronic dipstick is impervious to condensation, corrosion, or grime on the sensor element, a simple metal strip or dipstick-like wire several inches to dozens of feet long, depending upon the application. The system's electronics are based on low-cost components that fit on a small circuit board. Cost is so low that one licensee of our technology plans to retail gas-cap-mounted dipsticks at \$6 each.

Since development of MIR, initially invented as a diagnostic sensor for use by our Laser Programs, 30 patents have been applied for, 16 of these have been granted to date, and hundreds of commercial applications have been identified. The Laboratory has been following the dual paths of licensing the technology to qualified manufacturers and developing programs that use the technology in support of our missions.

Like conventional radar, MIR works by sending out a pulse and measuring its return. In MIR, however, each microwave pulse is less than 5 billionths of a second in duration; an MIR unit emits about two million of these pulses per second. Because current is only drawn during this short pulse time, power requirements are extremely low. One type of MIR unit can operate for years on a single AA battery.

*Contact: Tom McEwan (510) 422-1621 (mcewan1@llnl.gov).*

#### **SixDOF sensor provides manufacturing flexibility**

A small, noncontact optical sensor developed by the Laboratory will increase flexibility in manufacturing processes that employ robots. This invention does so by eliminating the time-consuming and expensive process of "teaching" robotic machinery new motions every time manufacturing changes are required.

Mounted on the tool head of a multi-axis robot arm, our six-degrees-of-freedom device (dubbed SixDOF) can sense its position relative to a workpiece, allowing the robot to autonomously follow a prescribed machining or manufacturing path. As the device's name indicates, SixDOF senses its position in all six degrees of freedom (the x, y, and z axes as well as the turning motion around those axes).

SixDOF is 250 times faster, 25 times more accurate, and one-sixth less expensive than its nearest competitor, which can detect only three degrees of freedom. The sensor works by emitting a laser beam and detecting the reflection off reference points mounted on the workpiece. Inside SixDOF, the beam is split and directed onto three photo diodes. The analog signals from the diodes are digitized and fed into a computer that can instruct corrective action or provide position readings.

The sensor could be used to control a six-degrees-of-freedom computer mouse, to assemble large and complex parts automatically, or to perform dangerous tasks remotely.

*Contact: Charles Vann (510) 423-8201 (vann1@llnl.gov).*

#### **Optical crystal delivers tunable ultraviolet laser**

Through an industrial partnership forged with II-VI Corporation of Tarpon Springs, Florida (formerly Lightning Optical Corporation), Lab scientists have developed and commercialized a new optical crystal—Ce:LiSAF—that, for the first time, makes an all-solid-state, directly tunable ultraviolet (UV) laser commercially viable.

The crystal consists of lithium-strontium-aluminum-fluorite (LiSrAlF<sub>6</sub>) doped with cerium (Ce), a rare-earth metal. Before the availability of this lasing medium, generating tunable UV light required multiple complex and sensitive nonlinear optical conversion steps. Ce:LiSAF eliminates these deficiencies.

Coupled with a compact solid-state laser, Ce:LiSAF yields a practical, robust laser system. Producing UV light directly and efficiently, it greatly expands laser applications; directly generating such light in a wide enough color band to provide straightforward "tunability" extends laser uses even more.

Ce:LiSAF lasers are particularly well suited to remote sensing applications. For example, a Ce:LiSAF laser could be used remotely to detect ozone and sulfur dioxide in the environment. Additionally, Ce:LiSAF lasers could be used to locate biological weapons remotely by detecting the presence of tryptophan, a common component of such weapons. The ultraviolet tunability provided by Ce:LiSAF also could be the basis for development of a UV differential absorption Lidar (laser radar) system. Another potential application is secure wireless communication links between infantry units in the battlefield.

*Contact: Christopher Marshall (510) 422-9781 (cmarshall@llnl.gov).*

#### **Sensor offers greater performance, reduced cost**

Teaming with the Read-Rite Corp. of Fremont, California, Laboratory scientists have developed an advanced magnetic sensor, a critical component in magnetic storage devices such as hard disk drives in computers. A typical disk drive in a computer would use 1 to 10 magnetic sensors.

Called the CPP-GMR (current-perpendicular-to-the-plane, magnetoresistance) sensor, this new invention offers greater sensitivity and 100 times greater storage densities than current commercial products. In fact, CPP-GMR storage density ranges from the current state of the art (about 1 gigabit per square inch) upward to the projected limit of magnetic disk drive technology (about 100 gigabits per square inch).

Built of alternating layers of thin magnetic materials and nonmagnetic materials, this giant GMR sensor uses thin-film technologies previously developed at Lawrence Livermore. Because the manufacturing process devised for the CPP-GMR does not require expensive fabrication tools, mass production costs can be kept low.

Because of the sensor's unique properties (it actually becomes more sensitive at the higher device densities needed for next-generation storage systems) and because of the simple manufacturing process employed, Laboratory scientists expect that magnetic heads using this sensor will enable the information storage industry to continue to develop higher density magnetic storage devices at reduced costs.

*Contact: Andrew Hawryluk (510) 422-5885 (hawryluk1@llnl.gov).*

#### **Tiny optical amplifier offers big boost to signal speed**

A dime-sized optical amplifier developed by the Laboratory has the potential for delivering a big boost to signals whizzing through 21st century data communications systems. This semiconductor optoelectronic device is designed to amplify optical signals at ultrahigh (terabit-per-second) rates. Such signal amplification or regeneration is essential in fiber optic communication systems where signals must be distributed over great distances and to a large number of customers.

The Laboratory's approach yields a component that is 100 times less costly, 1,000 times more compact, and more reliable than competing fiber amplifier technology. When produced in volume using present-day technologies, cost per unit is estimated to be as low as \$500. As low-cost manufacturing techniques are developed, the cost is estimated to drop to about \$50 per unit.

Essentially an optical analog of the electronic amplifier, which is ubiquitous in the electronic world, the Lab's miniature signal booster uses a tiny built-in laser system to eliminate crosstalk problems that have prevented deployment of more conventional semiconductor optical amplifiers.

Relying upon standard integrated circuit and optoelectronic fabrication technology, this device can be incorporated into many types of photonic integrated circuits. Potential applications include wide-area and local-area information networks, cable TV distribution, and computer interconnects.

*Contact: Mark Lowry (510) 423-2924 (lowry3@llnl.gov), Sol DiJaili (510) 424-4584 (dijaili@llnl.gov), or Frank Patterson (510) 423-9688 (patterson6@llnl.gov).*

#### **Lithography system proves boon for FEDs**

The Laboratory has made a significant advance in the effort to fabricate field emission display (FED) flat panels efficiently and cost effectively by demonstrating large-area laser

interference lithography. Laser interference lithography is a way to precisely and uniformly produce regular arrays of extremely small (less than 100 atoms wide) electron-generating field emitter tips that are at the heart of FED flat panel screens.

FEDs represent an advance over conventional flat panel display technology used in a wide range of consumer and military products—from digital watches to portable computers.

Field emission display panels consume less power than devices using competing active matrix liquid crystal display technology, a field dominated by Japanese companies. Compared to liquid crystal-based devices, field emission display panels can also be made thinner, brighter, lighter, and larger, and they have a wider field of view.

FEDs, however, have not been much of a player in the \$8-billion-a-year international flat panel market (projected to more than double by the end of the decade). Their primary drawback: expensive and complex micromachining technology needed for their fabrication.

The Laboratory's cost-effective fabrication technique, however, has potential to assure successful commercialization of large-area, high-performance FEDs. Potential applications range from more efficient and energy-conserving portable computers to virtual reality headsets and wall-hugging TV screens.

*Contact: Michael Perry (510) 423-4915 (perry10@llnl.gov).*

Each month in this space we report on the patents issued to and/or the awards received by Laboratory employees. Our goal is to showcase the distinguished scientific and technical achievements of our employees as well as to indicate the scale and scope of the work done at the Laboratory.

## Patents

Patent issued to	Patent title, number, and date of issue	Summary of disclosure
Thomas E. McEwan	<b>Phase Coded, Micro-Power Impulse Radar Motion Sensor</b>  U.S. Patent 5,519,400 May 21, 1996	A device for detecting a characteristic, such as motion, of objects within a range-gated field. A transmitter transmits a sequence of short electromagnetic pulses in response to a transmit timing signal at a nominal pulse repetition frequency. A receiver samples echoes of the sequence of pulses from objects within the field with controlled timing (in response to a receive timing signal) and generates a sample signal. The relative timing of the transmit-and-receive timing signals is modulated between first and second relative delays at an intermediate frequency.
Hugh R. Gregg Michael P. Meltzer	<b>Contamination Analysis Unit</b>  U.S. Patent 5,521,381 May 28, 1996	A unit that measures trace quantities of surface contamination in real time. The detector head of the portable contamination analysis unit has an opening with an O-ring seal, one or more vacuum valves, and a small mass spectrometer. With the valve closed, the mass spectrometer is evacuated with one or more pumps. The O-ring seal is placed against a surface to be tested, and the vacuum valve is opened. Data are collected from the mass spectrometer, and a portable computer provides contamination analysis.
Thomas E. McEwan	<b>Range-Gated Field Disturbance Sensor with Range-Sensitivity Compensation</b>  U.S. Patent 5,521,600 May 28, 1996	A low-power, low-cost, close-range sensor that transmits a sequence of bursts of electromagnetic energy to produce a sensor field. The transmitter frequency is modulated at an intermediate frequency. The sensor receives electromagnetic energy at the transmitter frequency. A transmitted burst is mixed with reflections of the same transmitted burst to produce an intermediate frequency signal, which indicates a disturbance in the sensor field and defines the sensor range.
Leonard C. Haselman, Jr.	<b>Free Form Hemispherical Shaped Charge</b>  U.S. Patent 5,522,319 June 4, 1996	A charge that has been modified such that the liner is aspherical and allows an aspherical wall thickness variation. The liner has a thick wall at its pole and a thin wall at the equator with a continually decreasing wall thickness from the pole to the equator. The ratio of the wall thickness from the pole to the equator varies depending on the liner material and the desired jet properties. By redesign of the basic liner thicknesses, the jet properties of coherence, stability, and mass distribution have been significantly improved.

## Awards

**Bill Hogan** has been awarded the **1996 Outstanding Achievement Award** by the Fusion Energy Division of the American Nuclear Society for his pioneering work in inertial fusion energy. Hogan has been a key player in the development of the field of inertial fusion energy as a respected branch of fusion research. A Laboratory physicist since 1966, he is well known as a spokesman for the National Ignition Facility and a proponent for inertial fusion energy applications beyond NIF. He is also an advocate of fusion energy internationally, and since 1992, he has served as chairman of the Vienna-based International Atomic Energy Agency's advisory committee on fusion energy. He was recently elected vice chair/chairman-elect of the 1,000-member ANS fusion division.

**Peter Fiske** was recently awarded the prestigious **White House Fellowship** by President Clinton. One of eight men and ten women to receive the award, Fiske is a post-doctoral research associate in the Laboratory's Institute of Geophysics and Planetary Physics. He recently published a book, *To Boldly Go... A Practical Career Guide for Scientists*, which is about the future of scientific research and development in the post-Cold War era and the career crisis he and other post-doctoral fellows face in today's job market.

Laboratory employee **Bart Hacker** was the recipient of the 1996 **Richard W. Leopold Prize** from the Organization of American Historians for his book *Elements of Controversy: The Atomic Energy*

*Commission and Radiation Safety in Nuclear Weapons Testing, 1947-1974*. Established in 1984, the biennial Leopold Prize recognizes significant historical work being done by historians outside academia. Hacker joined the Laboratory in 1992 as a science and technology historian and is currently the editor of *National Security Science and Technology Review*, the Laboratory's classified quarterly journal.

**David Zalk** has been awarded the **John J. Bloomfield Award** by the American Conference of Governmental Industrial Hygienists for his pioneering work in custodial ergonomics and asbestos handling procedures. The Bloomfield award is presented annually to a hygienist with less than ten years' experience "who pursues problems of occupational health hazards primarily via field work, and demonstrates significant contribution to the profession." Zalk has been employed by the Laboratory's Hazards Control Department as an industrial hygienist for three years.

Two Laboratory Scientists—**Rick Ryerson**, of the Institute of Geophysics and Planetary Physics, and **Luiz Da Silva**, from the Laser Programs Directorate—have been selected as **Distinguished Lecturers for Associated Western Universities** for the 1996-97 academic year. Ryerson and Da Silva join a list of Laboratory colleagues who have received this honor since 1989. Ryerson is currently specializing in using different dating methods for rocks to determine the slip rates along faults associated with the Indo-Asian collision and the uplift of Tibet. Da Silva is an expert in the uses of optical lasers for medical applications.

## Taking Lasers beyond the National Ignition Facility

High-energy solid-state lasers have been shown to be useful for studying the plasma physics of fusion, the national objectives of stockpile stewardship, and possibly future energy production. Solid-state lasers based on flashlamp pump sources will achieve ignition and explore weapons issues during the beginning of the next century. Diode-pumped solid-state lasers represent a next step in continuing to pursue laser fusion after startup and operation of the National Ignition Facility. In addition to offering us a pathway to future inertial fusion studies and stockpile stewardship applications near-term uses for advanced high-repetition-rate lasers also abound. Our small-scale experiments at Lawrence Livermore attest to the scientific viability of diode-pumped solid-state lasers for fusion, as do the synergistic laser development efforts in support of numerous military, governmental, and civilian applications.

### ■ Contact:

**Steve Payne** (510) 423-0570 ([payne3@llnl.gov](mailto:payne3@llnl.gov)) or  
**Chris Marshall** (510) 422-9781 ([cmarshall@llnl.gov](mailto:cmarshall@llnl.gov)).

## Jumpin' Jupiter! Metallic Hydrogen

The most abundant element in the universe, hydrogen plays a significant role in our defense and laser fusion programs. As a result, we have a continuing interest in better understanding hydrogen's behavior at high temperature and pressure. Recently we succeeded in achieving a long-sought goal of high-pressure physics—converting hydrogen to a metal. The prediction that hydrogen would turn metallic at extremely high pressures was first theorized in 1935, but tangible evidence eluded scientists during the intervening decades. We approached metallization differently from others, applying a series of relatively weak shock compressions to targets of liquid, rather than solid, hydrogen.

### ■ Contact:

**William Nellis** (510) 422-7200 ([nellis1@llnl.gov](mailto:nellis1@llnl.gov)).

© 1996. The Regents of the University of California. All rights reserved. This document has been authored by the The Regents of the University of California under Contract No. W-7405-ENG-48 with the U.S. Government. To request permission to use any material contained in this document, please submit your request in writing to the Technical Information Department, Publication Services Group, Lawrence Livermore National Laboratory, P.O. Box 808, Livermore, California 94551, or to our electronic mail address [report-orders@llnl.gov](mailto:report-orders@llnl.gov).

This document was prepared as an account of work sponsored by an agency of the United States Government. Neither the United States Government nor the University of California nor any of their employees makes any warranty, expressed or implied, or assumes any legal liability or responsibility for the accuracy, completeness, or usefulness of any information, apparatus, product, or process disclosed, or represents that its use would not infringe privately owned rights. Reference herein to any specific commercial product, process, or service by trade name, trademark, manufacturer, or otherwise, does not necessarily constitute or imply its endorsement, recommendation, or favoring by the United States Government or the University of California. The views and opinions of authors expressed herein do not necessarily state or reflect those of the United States Government or the University of California and shall not be used for advertising or product endorsement purposes.